

LOC	DIST	REVISIONS			
P	LTR	DESCRIPTION	DATE	DWN	APVD
E	B	A1	REVISED PER ECO-11-005150	29MAR2011	RK HMR

FOR FURTHER INFORMATION SEE DATA SHEET FOR
CBT SERIES-CARBON COMPOSITION RESISTORS

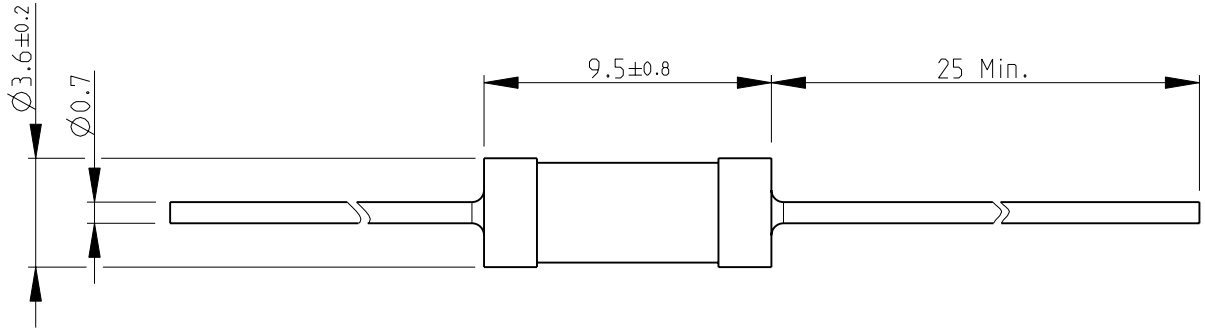

RoHS Compliant

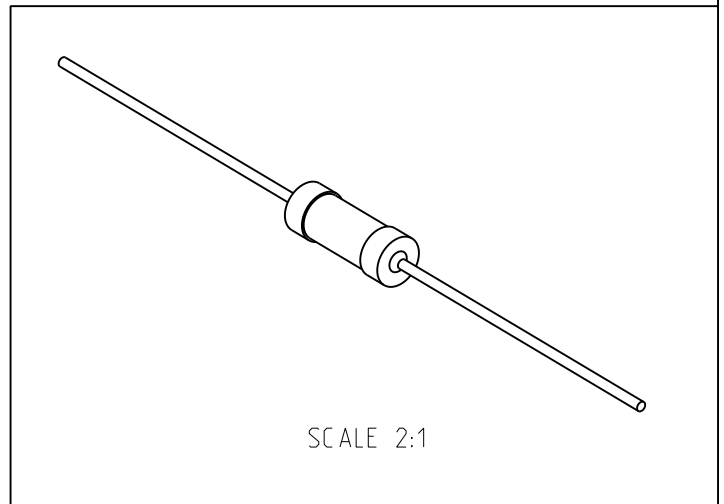

SCALE 2:1

2008

RELEASED FOR PUBLICATION

ALL RIGHTS RESERVED.

THIS DRAWING IS UNPUBLISHED.

BY -

© COPYRIGHT 2008

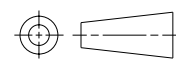
DIMENSIONS:		DWN	18-Sep-08	MATERIAL	-	FINISH	-
mm		SUBHASH.M		 TE Connectivity			
TOLERANCES UNLESS OTHERWISE SPECIFIED:		CHK	18-Sep-08				
0 PLC	± 0.2	APVD	18-Sep-08	NAME CARBON COMPOSITION RESISTORS SERIES CBT50			
1 PLC	± 0.1	STEPHEN.P					
2 PLC	\pm	PRODUCT SPEC	-	SIZE	CAGE CODE	DRAWING NO	RESTRICTED TO
3 PLC	\pm	APPLICATION SPEC	-	A 4	00779	C-1625876	-
4 PLC	\pm	WEIGHT	-	CUSTOMER DRAWING			
ANGLES	$\pm 5^\circ$			SCALE	4:1	SHEET	1 OF 1
						REV	A1